

DRG.NO

EF315M-4-B3

FRAME

EF315M-4

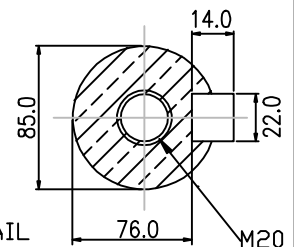
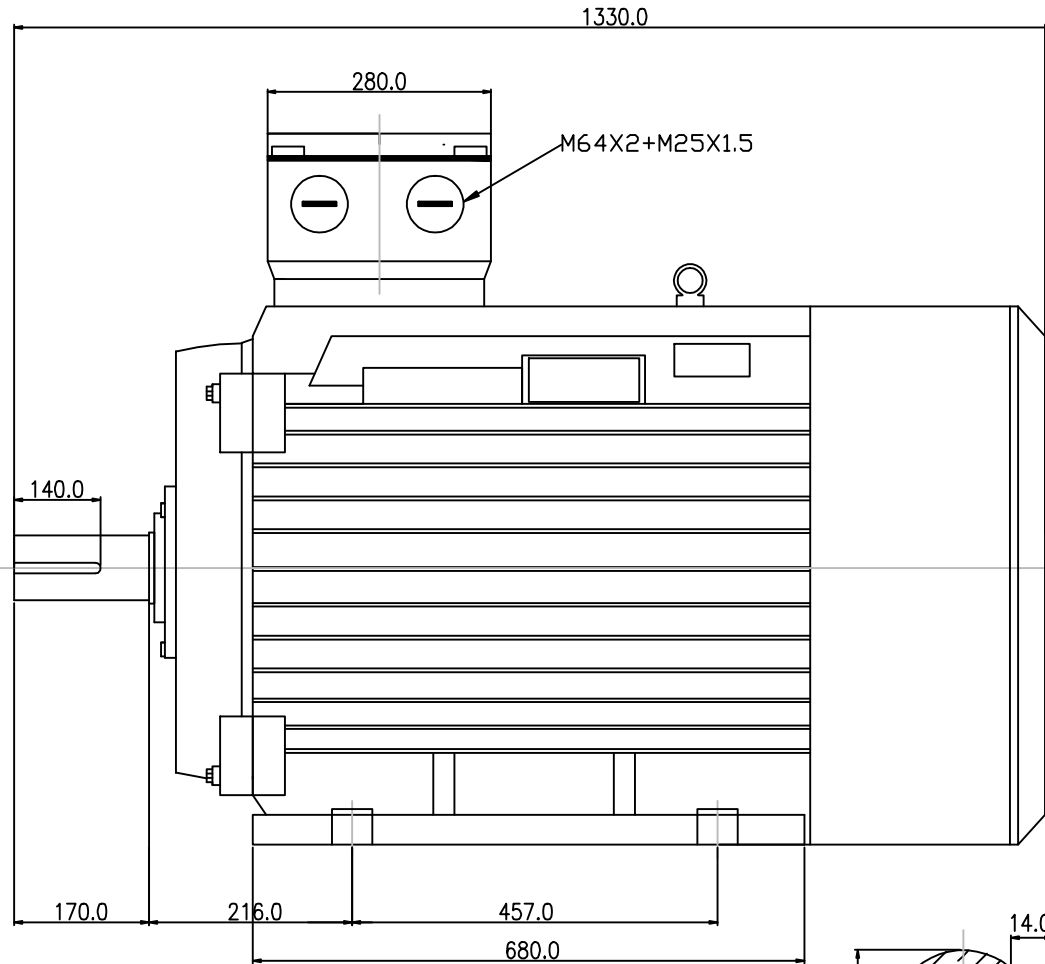
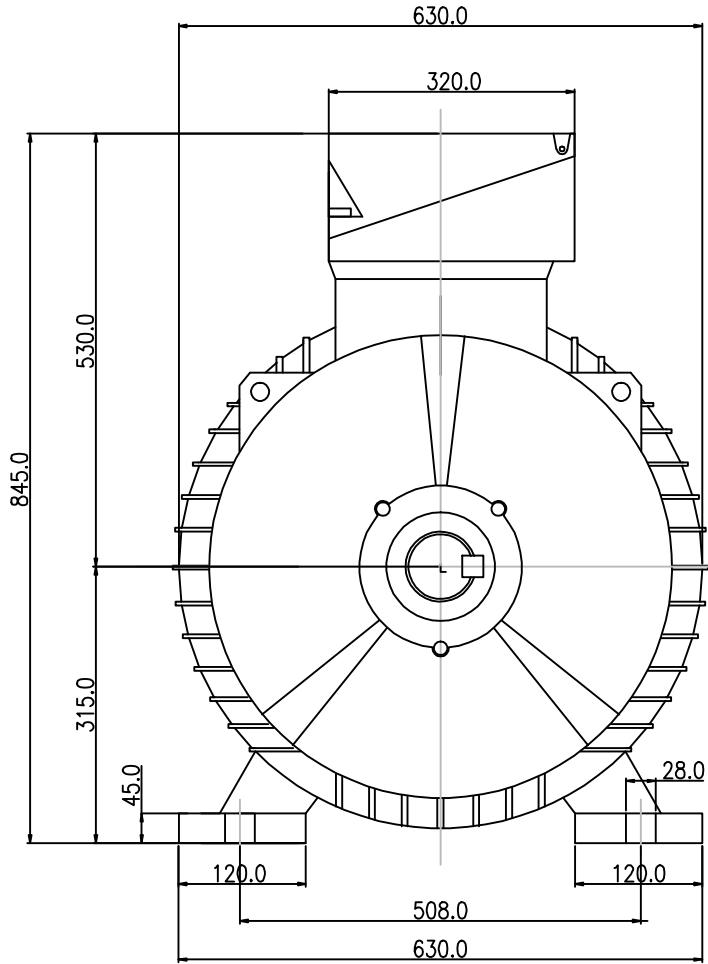

SHAFT DETAIL



3 CORD STREET  
 DUDLEY PARK SA 5008  
 Ph: (08) 8269 4000  
 Fax: (08) 8269 4000  
 www.roycecross.com.au



DRAFTING  
 STANDARD  
 AS 1100

SIZE  
 A4

ALL DIMENSIONS ARE IN mm  
 UNLESS OTHERWISE SPECIFIED  
 TOL. 1 PLACE DECIMAL  $\pm 0.25$  ANGLE  $\pm 0.30^\circ$   
 2 PLACE DECIMAL  $\pm 0.13$

MATL SPEC

TITLE  
 THREE PHASE INDUCTION MOTORS-TOP TERMINAL BOX  
 (FOOT MOUNT B3 EF315M-4)

DRN	NL	DATE	4.12.08
CHK		APPD	
SCALE	NTS		

DESCRIPTIONS  
 SHAFT TYPE EF315-4

BRAND



DRG NO

EF315M-4-B3

REV

CODE No.