

DRG.NO

EF225S-4-B3

FRAME

EF225S-4

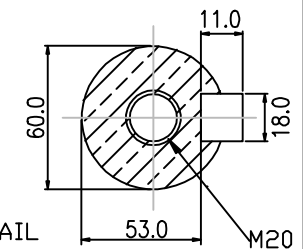
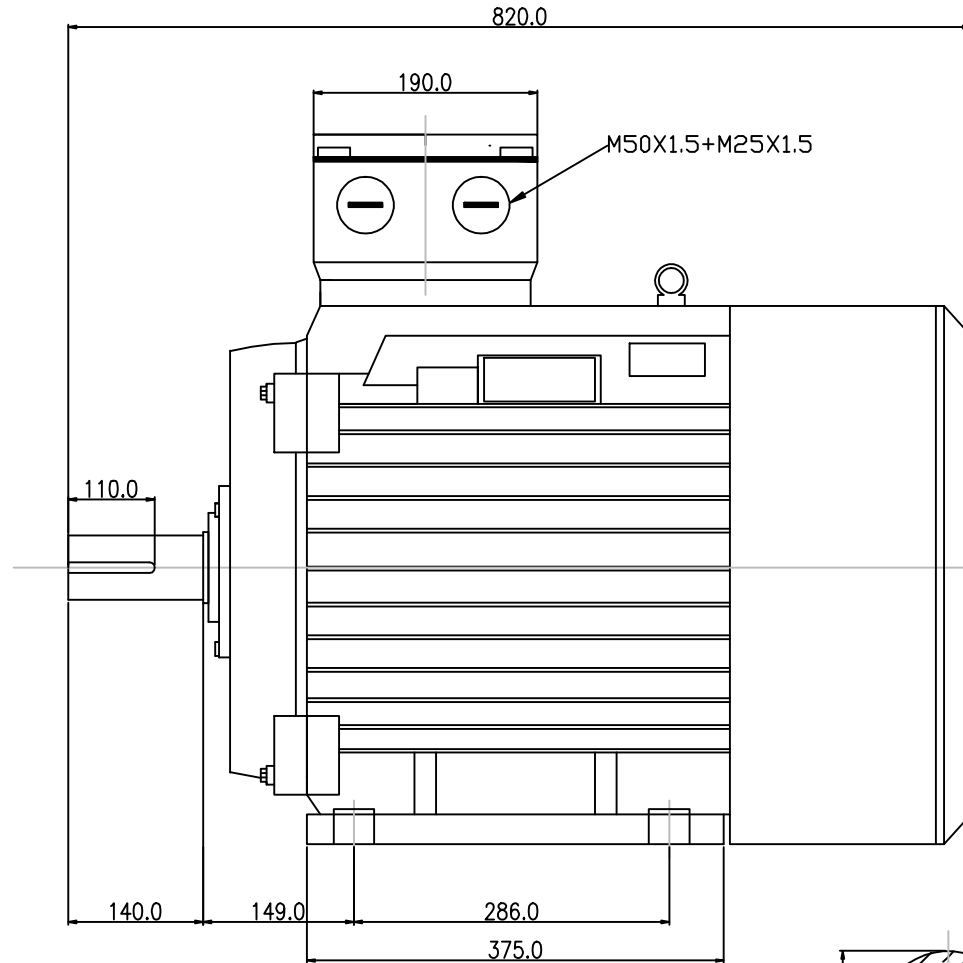
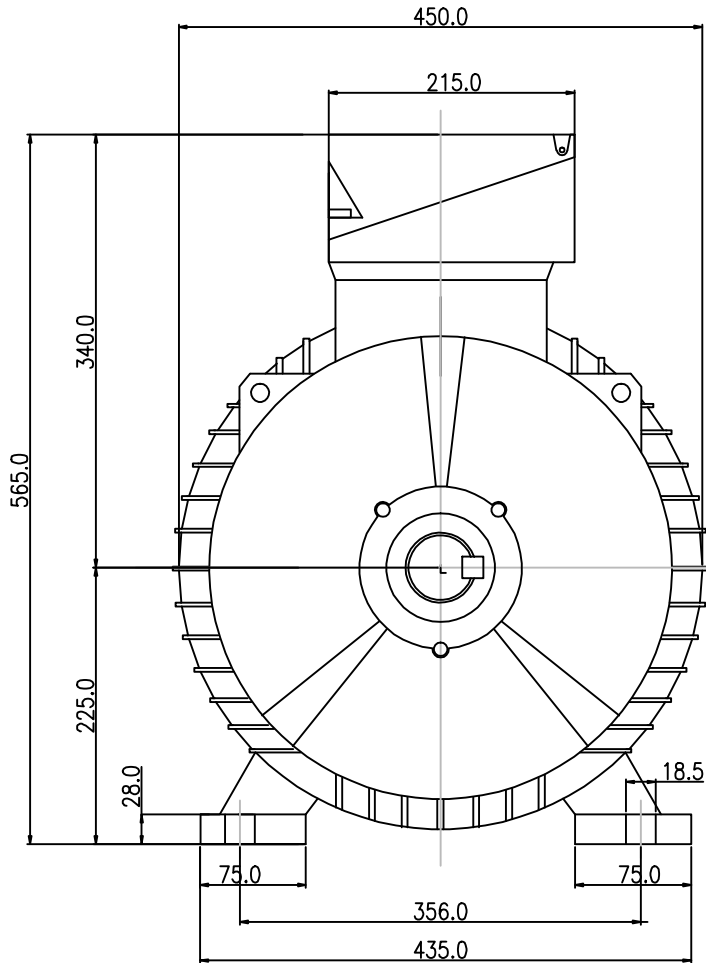

SHAFT DETAIL



3 CORD STREET
 DUDLEY PARK SA 5008
 Ph: (08) 8269 4000
 Fax: (08) 8269 4000
 www.roycecross.com.au



DRAFTING
 STANDARD
 AS 1100

SIZE
 A4

ALL DIMENSIONS ARE IN mm
 UNLESS OTHERWISE SPECIFIED
 TOL. 1 PLACE DECIMAL ± 0.25 ANGLE $\pm 0.30'$
 2 PLACE DECIMAL ± 0.13

MATL SPEC

TITLE
 THREE PHASE INDUCTION MOTORS-TOP TERMINAL BOX
 (FOOT MOUNT B3 EF225S-4)

DRN	NL	DATE	8.12.08
CHK		APPD	
SCALE	NTS		

DESCRIPTIONS
 SHAFT TYPE EF225-4

BRAND		
DRG NO	EF225S-4-B3	REV
CODE No.		